



# VOLTIC

PHOTOVOLTAIC CONTROLLER  
FOR WATER HEATING



User manual

# Content

---

|                                   |           |
|-----------------------------------|-----------|
| <b>Introduction.....</b>          | <b>3</b>  |
| <b>Installation.....</b>          | <b>4</b>  |
| Photovoltaic panels.....          | 4         |
| Water heater.....                 | 4         |
| Wires section.....                | 4         |
| Mounting.....                     | 4         |
| Electrical connection.....        | 5         |
| <b>User interface.....</b>        | <b>6</b>  |
| Main screen.....                  | 6         |
| Operation mode.....               | 6         |
| State.....                        | 7         |
| Statistics.....                   | 7         |
| Main Menu.....                    | 8         |
| Temperatures.....                 | 8         |
| Additional.....                   | 8         |
| Display.....                      | 8         |
| Information.....                  | 8         |
| Date & Time.....                  | 9         |
| tRemote WiFi.....                 | 9         |
| Factory reset.....                | 9         |
| <b>Errors and protection.....</b> | <b>10</b> |
| <b>Technical data.....</b>        | <b>11</b> |
| <b>Limited warranty.....</b>      | <b>12</b> |
| <b>Warranty card.....</b>         | <b>12</b> |

# Introduction

---

**VOLTIC** is innovative system for water heating capturing fully the solar energy coming from photovoltaic panels. The intermittent energy of the sun is stored in water heater so it can be used when needed – day or night. Standard heating element is used with no need of wiring modification. There is no need of additional installation as pipes, valves or pumps unlike the solar thermal systems. The simplicity of the system along with the panel long life, guarantee minimal maintenance and good investment in the long run.

## Main advantages of the system:

- Eliminating the risk of overheating, in the case of excess energy, the controller terminates the water heating which does not damage the panels
- Eliminating the risk of freezing, the photovoltaic panels increase their efficiency at lower temperatures
- MPPT algorithm ensures that the maximum available power is produced from the sun, independent of the system setup or the solar radiation intensity.
- Automatic additional heating from mains when needed, according to user preset conditions, taking into account day and night tariff
- High efficiency (up to 98%) of the controller, as there is no need to convert the direct current (DC) from the panels to alternating current (AC)
- Autonomy, it works without mains power
- Analysis of the system efficiency via detail monitoring and logging of the produced energy and visualizing it on the graphical display
- Multiple protections in the controller protect the whole system in extreme cases
- Remote control and monitoring by WiFi module and mobile application

# Installation

## Photovoltaic panels

- Power of the installed panels should NOT exceed **2.4 kW**
- The panels are connected in series, as the open circuit voltage **V<sub>oc</sub>** should NOT exceed **250V**, and the maximum power point current **I<sub>mp</sub>** should NOT exceed **14A**
- The panels should be connected through external switch and fuse, which are appropriate for the power of the installation.



**CAUTION! It is mandatory to match the polarity of the PV input! Reverse polarity connection will result in device damage!**

## Water heater

- Heating element power should be higher than the panels peak power (1kW – 3kW)
- Make sure the water heater safety systems are in order – thermal protection and pressure relief valve
- Set thermostat temperature higher than the desired water set temperature from the controller or put it on maximum.
- Water heaters with additional circuitry are not supported, power them directly to the heating element, including the safety systems
- It is recommended to mount the temperature sensor in the top part of the water heater, making sure the sensor housing is in contact with the metal tank.

## Wires section

| Terminal        | Strip    | Recommended section          | Maximum section              |
|-----------------|----------|------------------------------|------------------------------|
| Photovoltaic    | 13-14 mm | 4 mm <sup>2</sup> / 12 AWG   | 6 mm <sup>2</sup> / 10 AWG   |
| Heating element | 12-13 mm | 1.5 mm <sup>2</sup> / 15 AWG | 2.5 mm <sup>2</sup> / 13 AWG |
| Mains           | 12-13 mm | 1.5 mm <sup>2</sup> / 15 AWG | 2.5 mm <sup>2</sup> / 13 AWG |

## Mounting



**The device is for home use only! Do not mount it in moist places as bathroom! Make sure there is enough space for air circulation!**

The device should be mounted vertically, hanging on 2 screws, spaced 174 mm apart, as shown on the drawing. Keep clear distance of at least 100 mm beneath and over the device for optimal cooling.

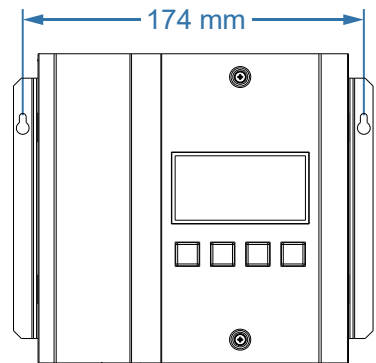

## Electrical connection



**WARNING HIGH VOLTAGE!** The connection should be performed by authorized personnel only, while the PV and mains breakers are disconnected!



**It is mandatory to connect the protective earth PE terminals from mains and to the heater!**

1. Connect the water heater power along with PE
2. Mount the temperature sensor on the water heater and plug the connector
3. Connect the two PV cables, keeping the indicated polarity correct
4. Connect the mains terminal

*If the device is used in standalone mode (no mains power), connect the PE mains terminal and leave N & L terminals unconnected./*

When all the inputs and outputs are connected, power the system by switching on the circuit breakers for the panels and mains. The device turns on when if there is enough power from the solar panels or is connected to mains power.

The temperature sensor has no polarity and the cables can be extended if needed.

Besides water heater heating element, another heating device can be used, as long as it is of purely resistive type and has no additional electronic circuitry.

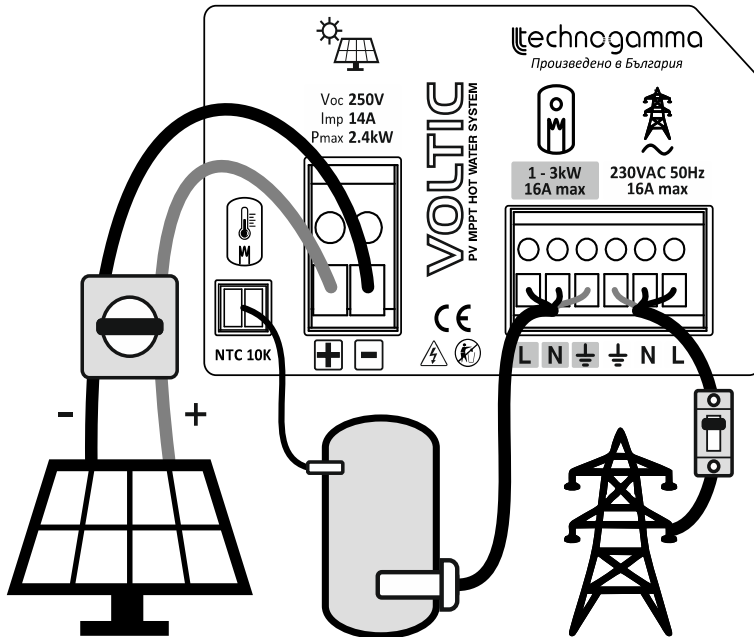

# User interface

## Main screen

The mains screen presents detail information of the current state of the device. On the screen are shown the operation mode, power source along with its power, temperature of the water heater and the daily energy produced.

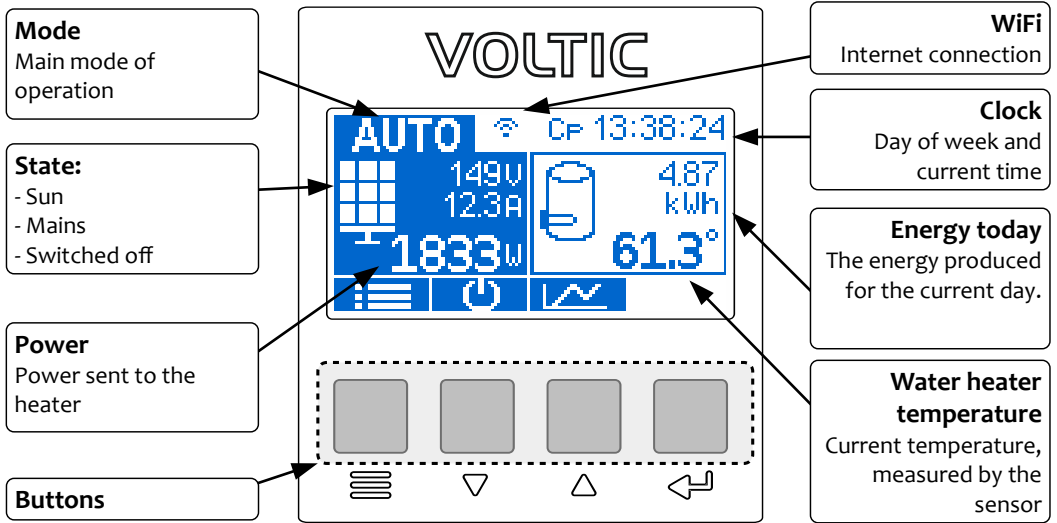

Use the four buttons, situated below the display, for control and navigation. On the main screen they have special functions for easier access, which are depicted on the bottom of the display:

| Button | Main screen    | Navigation      |
|--------|----------------|-----------------|
|        | Main menu      | Back, cancel    |
|        | Switch mode    | Down, decrease  |
|        | Savings screen | Up, increase    |
|        |                | Select, confirm |

Use the buttons / to navigate and to enter into the currently highlighted menu element. Press the button in order to get a level up, from the main menu it takes you to the main screen.

## Operation mode

Press button from the main screen in order to change the mode. Choose an element from the pop-up menu and confirm it with in order to apply it.

**AUTO** the water heater is heated from the sun until a maximum temperature is reached, if the temperature falls below a minimum set point (daily and nightly), the device switches to mains power until it is reached.

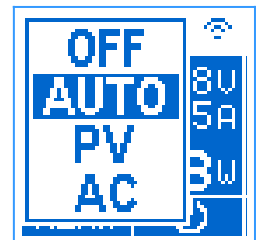



- PV** heating only from solar power until the maximum temperature is reached
- AC** heating from mains only until the maximum temperature is reached
- OFF** the two power sources are disconnected at all times

You can adjust the temperatures from screen **Temperatures**.

## State

The current source that powers the heater:

 Photovoltaic panels and the current power produced, additionally the voltage and current of the panels are shown

 Night mode, the panels voltage is below a minimum threshold (40V), the heater is off

 Mains grid and the power of the heater which is set by the user

 Heater turned off, if the reason for turning off is exceeding temperature above the maximum set, then it is indicated by showing the value of the set temperature (**Max 71.0°**)

## Statistics

Press the button  from the main screen to access the statistical functions. As the device is operating, it stores in its persistent memory the energy consumed by the heater.

Screen **Savings** provides summarized information about the saved energy for different current periods (day, month, year) and also for the total life of the device. You can select a specific period to access detailed graphical information.

The stored records for the selected time period are show, along with their total value. Use the arrows to navigate and select an element by pressing  to see detail view. According to the period the bars represent:

- Day - 24 hours
- Month - 28 - 31 days
- Year - 12 months

The detail view has a description of the element, total energy in kWh and Y axis grid to show the values of the bars. With the arrows you can change the current time element, which corresponds to the previous screen list.

For each day, additional hourly water heater temperature value us recorded, which is shown with **+** symbol. On the right side of the Y axis grid are the values in degrees C so the temperature value can be determined.



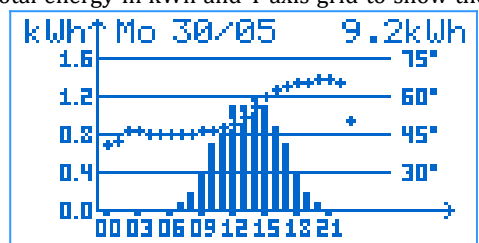
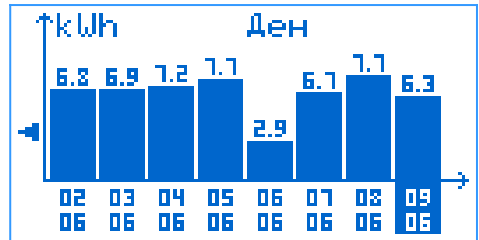

| Savings | EUR  | kWh  |
|---------|------|------|
| Today   | 1.06 | 4.8  |
| Month   | 0.00 | 0.0  |
| Year    | 0.00 | 0.0  |
| Total   | 1484 | 6749 |

Choose for graph



## Main Menu

In order to access the main menu, press button  from the main screen.

In the following screens, you can start editing parameter value after pressing . In edit mode the parameter value is blinking and using the buttons / you can decrease / increase it. When you are done editing, press  to save or  to discard the changes.

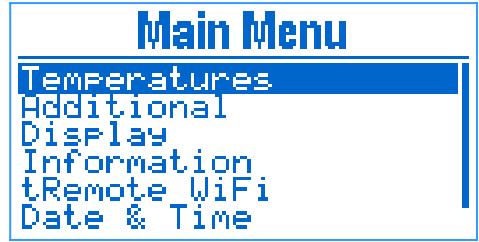

## Temperatures

**Min Day / Min Night** – below this threshold the device switches to mains power in **AUTO** mode

**Day start / Night start** – time of the beginning of the period

**PV Max** – maximum threshold for stopping the heating from the sun in **AUTO** & **PV** modes

**AC Max** – maximum threshold for stopping the heating from mains **AC** mode

**Hysteresis** – hysteresis applied on the set temperatures

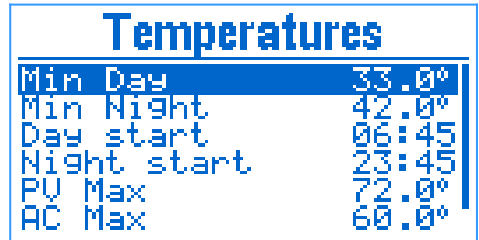

## Additional

**Tariff kWh** – price of the mains electric energy used to calculate the value of savings

**Heater** – the power of heater used for logging the energy consumed from mains



## Display

**Language** – user interface language

**Brightness** – screen backlight intensity in active mode

**Brightness Min** – screen backlight intensity in idle mode – 60 sec after the last button press

**Contrast** – display contrast



## Information

Device detail information: version, maximum power reached, input and output voltage/current and power, MPPT module operation and temperature of the PCB.

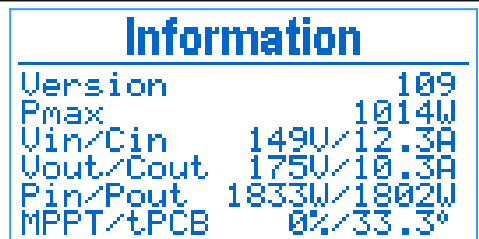



## Date & Time

Set the time and date of the system clock of the controller. The time format is hh:mm:ss and the date format is DD/MM/YYYY. Pressing  over the seconds field resets it. All other fields are edited using the standard way parameter is edited. The week day is automatically set, based on the date entered.

The realtime clock is battery backed so in case of power loss it is kept running. If the device is connected to internet, then the time and date can be synchronized automatically if you choose the **Synchronize** option.



## tRemote WiFi

If you have WiFi module installed, on this screen you can see if the device is connected to the remote control and monitoring system **tRemote**.

If you are configuring your device for the first time, then it will be in **Select WiFi** mode (*more information in tRemote connect manual*).

When the device is setup and connected to the server, then connection the state will be **tRemote Online**. The parameters of the connected WiFi network are show on the screen and the field **tPell ID** is the identifier used in tRemote. Use the QR code to easily register the device upon registration.

Use the button **New WiFi** to configure new connection to new WiFi network. Upon confirming the confirmation dialog, the device enters **Select WiFi** mode.

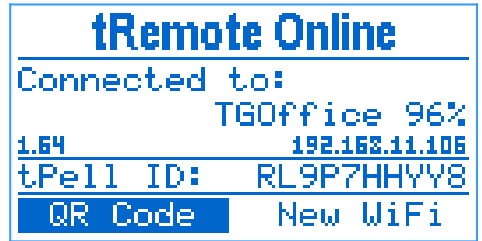

## Factory reset

Reset the factory values of all parameters. Confirm your choice by selecting **OK** and pressing .



# Errors and protection

In case of detecting abnormal operation conditions, the following errors/warnings are shown on the main screen:

| Message                   | Action        | Details  |
|---------------------------|---------------|--|
| <i>Voltage HIGH</i>       | PV stops      | Panel voltage exceeding limit (250 V)  |
| <i>Current HIGH</i>       | PV stops      | Panel current exceeding limit (14 A)   |
| <i>Heater SHORTED</i>     | Mode OFF      | Short-circuit on the output is detected. The device turns itself off, the user need to manually turn it on to continue operation.                                |
| <i>OVERHEATED</i>         | PV stops      | The device has overheated. After the internal temperature falls down below the threshold, the device will resume operation. Check the cooling and fan operation. |
| <i>Temperature SENSOR</i> | PV & AC stop  | The temperature sensor is malfunctioning or disconnected, check its electrical connection.   |
| <i>Check cooling</i>      | Power reduced | High internal temperature has been reached. Check the fan and ventilation is appropriate   |
| <i>Heater Open</i>        |               | No current is flowing through the connected load. Check the electric connections and the water heater thermostat.  |

When an overload of the device is detected (current, voltage, power or internal temperature), the power delivered to the load is decreased, until the cause of the overload is goes away. This way the device is protected from damage lowering the power produced from the panels.

The device has surge protection installed on both the PV and mains inputs. If the installation is situated in high risk thunderstorm and lightning strike area, then it is recommend to install additional lightning protection system.

# Technical data

---

## Input PV DC

|   |            |
|---|------------|
| <b>P<sub>m</sub></b> – maximum power          | 2.4 kW     |
| <b>V<sub>oc</sub></b> – open circuit voltage  | 250 V      |
| <b>I<sub>mp</sub></b> – maximum power current | 14 A       |
| MPPT voltage range                            | 60 – 200 V |
| MPPT trackers                                 | 1          |

## Input Mains AC

|                          |              |
|--------------------------|--------------|
| Voltage                  | 230 V, 50 Hz |
| Maximum switched current | 16 A         |
| Self consumption         | < 3 VA       |

## Output

|  |           |
|--|-----------|
| Heater power at 230 VAC                | 1 – 3 kW  |
| Heater resistance                      | 16 – 53 Ω |
| Load type                              | Resistive |
| Compatible with thermostat / AC switch | YES       |
| DC voltage range                       | 0 – 220V  |
| Maximum efficiency                     | ≥ 98%     |

## Other

|                    |                            |
|--------------------|----------------------------|
| Cooling            | Temperature controlled fan |
| Display            | Graphic 128 x 64 px        |
| Temperature sensor | NTC 10k                    |

## General

|                     |                   |
|---------------------|-------------------|
| Dimensions          | 184 x 160 x 83 mm |
| Weight              | 1.4 kg            |
| Ambient temperature | 0 – 35 °C         |
| Relative humidity   | < 95 %            |
| IP rating           | IP 20             |
| Warranty            | 24 Months         |

# Limited warranty

---

The warranty is valid for 24 months from the date of sale.

Warranty void if:

- Incorrect installation
- Alteration of the product and/or attempts to repair or modify
- Visible damage of the housing and/or the inside of the device
- Damage caused by lightning storms
- Usage in inappropriate conditions (temperature and humidity)
- Broken warranty stickers

## Warranty card

---

Sold (client / date): \_\_\_\_\_

\_\_\_\_\_

Invoice # (Receipt): \_\_\_\_\_

Signature: \_\_\_\_\_

### Technogamma LTD

4004 Plovdiv, Bulgaria

9N Kuklensko Shose str. fl. 3, office 6

Phone: +359 32 699-240

E-mail: [info@technogamma.bg](mailto:info@technogamma.bg)

[www.technogamma.bg](http://www.technogamma.bg)